



**MJC
Cartridge Filter**

MJC

Features

***Metal • Cement • Powder Bulk • Welding • Plastic
Petro-Chemical • Pharmaceutical • Food***

Suitable for many different applications that generate light to heavy volumes of any dust



1,000 to 40,000 CFM

- Strength independently tested and verified.
- Suitable for explosive dusts St1, St2 and St3 with ATEX certified components.
- No-tool cartridge replacement in safe working location.
- Top (clean air) cartridge replacement.
- Ledge free dirty air chamber.
- High level down-flow dirty air inlet.
- Built-in pre-separation chamber enables bigger dust loads; reduces cartridge wear.
- Available with or without hopper.
- Crossflow / downflow dirty air distribution allows more effective cleaning on-line.
- Robust, weatherproof, long lasting welded steel construction for tough industrial environments.
- Negative operating pressures up to 32" wg standard. Higher pressures plus positive pressure optional.
- Built-on fans up to 25hp save floor space, or separate fan if desired.
- Optional air inlet, outlet and explosion panel positions to suit site location.
- Filter cleaning controller easily programmed to suit almost all operating patterns.
- Benefits from over 15 years development and use in hundreds of installations.
- Vertical tubular cartridges shed dust easily.
- Dantherm's patent UniClean cartridges clean from top to bottom with maximum efficiency saving energy costs and offer longer life.

How It Works

...during normal operation

1. During normal operation, the dust laden air from the plant travels down the supply duct 1
2. A vertical slotted baffle 2 separates the inlet section that slows the airstream and directs dust downward into the hopper, 3, protecting the cartridges from direct abrasion but allowing air to pass horizontally between them.
3. The lighter dust collects on the outside of the filter cartridges 4 as clean air passes through to the inside of each cartridge 6. Finally, the clean air travels through the air outlet 5 where it could be returned to the plant or exhausted outdoors.
4. The heavier dust settles in the hopper section 3 where it can be discharged into a metal bin 7 or through a rotary air lock

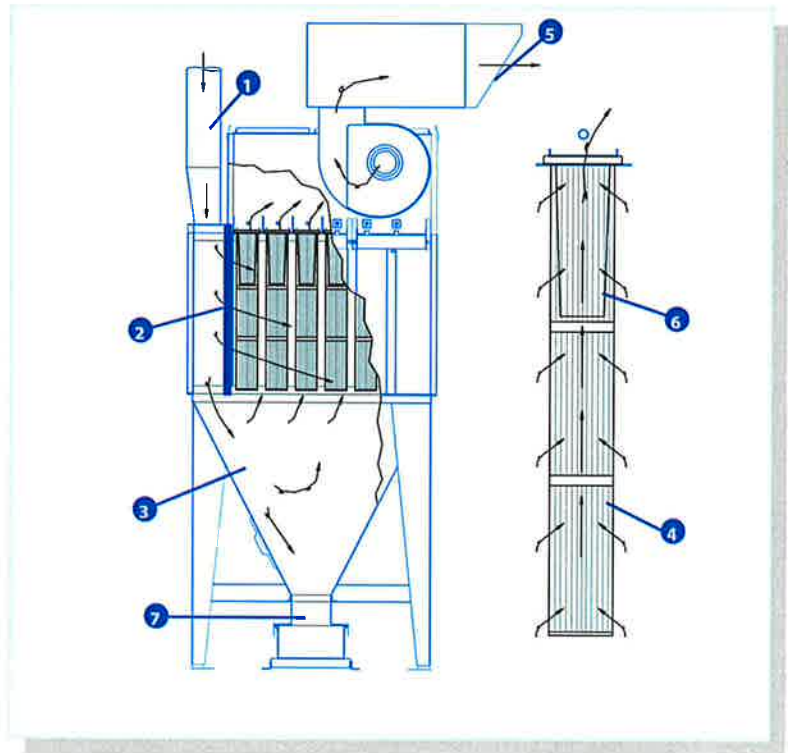

...while cleaning

1. The MJC can utilize a Delta-P gauge to control the compressed air cleaning. In essence, the filter cleans itself when it needs to!
2. A compressed air line must be connected to one end of the compressed air manifold 8
3. A solenoid valve opens to allow compressed air from the manifold 8 into the jet tubes 9. The jet tubes are aligned above each row of cartridges.
4. The downward blast 10 blows the dust off the cartridges (from the inside out) 4 where it settles into the hopper section 3 to be collected in the metal bin 7 or discharged through a rotary air lock.

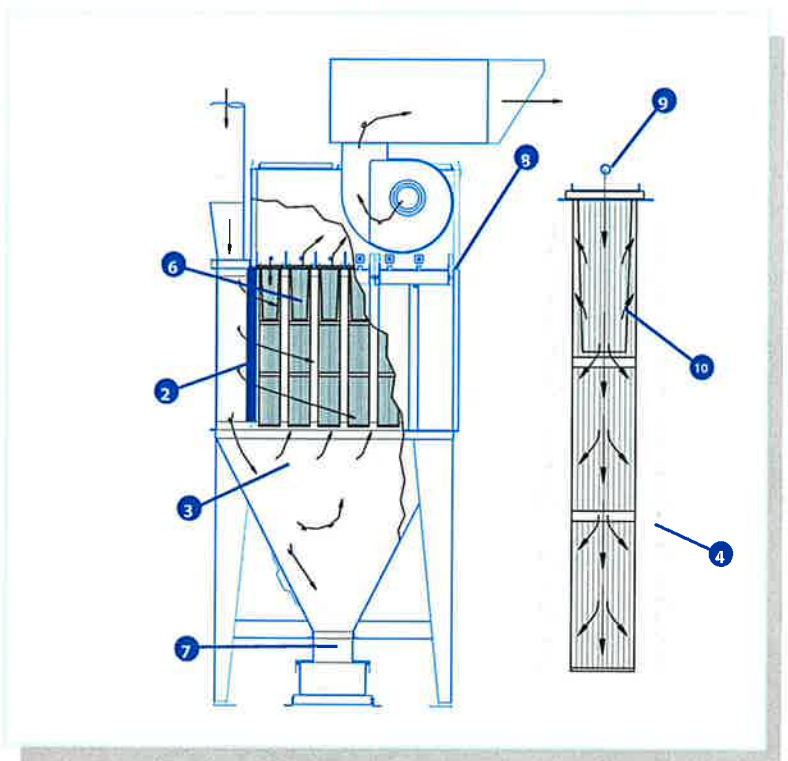

NOTE: Please consult with your Dantherm Filtration representative for compressed air requirements

Planning-in Data

MJC-M Medium length bag

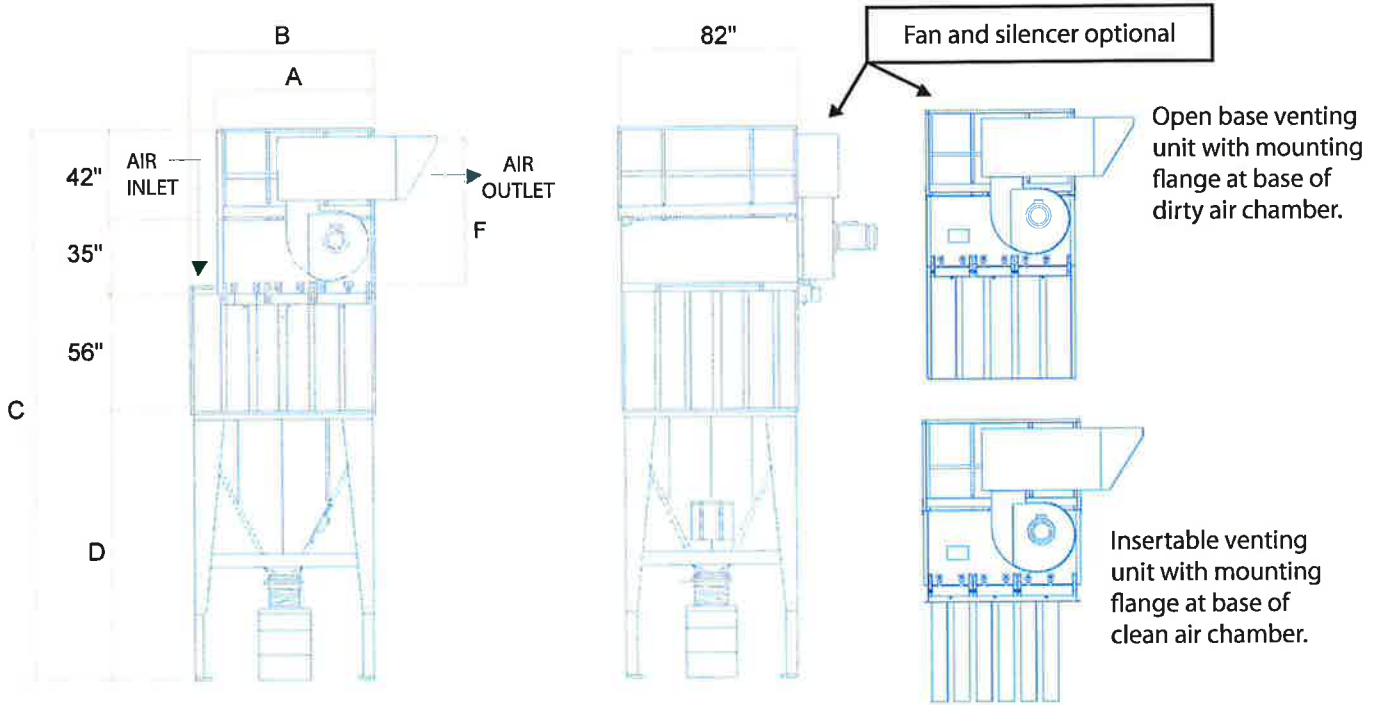

Front and side view of standard MJC complete with typical fan and silencer, mounted on a bin hopper. Rotary valve, flap valve and other discharge options available.

Add fan plus silencer weight for For dimension F.

Fan size HP	Fan + Silencer Weight lbs	Dimension F
Up to 4.0	150	4'7"
5.5 to 10-5	240	5'7"
10-L to 25	415	6'1"

MJC "XL"	Total Cartridges	Total Surface Area Sq Ft.	Max Air Volume (cfm)	Width of Clean air chamber	Width of Dirty air chamber and hopper	Filter Height								Filter Weight and Hopper (lbs)	Hopper Outlets Number of Drums
						w/ 20 gallon bin		w/ 26 gallon bin		w/ 55 gallon drum		w/ rotary airlock			
						C ₁	D ₁	C ₂	D ₂	C ₃	D ₃	C ₄	D ₄		
158/66/3-8	24	1701	8520	3'- 9"	4'- 11"	18'- 6"	7'- 5"	19'- 4"	8'- 3"	20'- 11"	9'- 10"	22'- 3"	11'- 2"	3457	1
211/66/4-8	32	2271	11360	4'- 11"	7'- 3"	19'- 1"	8'- 0"	19'- 11"	8'- 10"	21'- 6"	10'- 5"	22'- 10"	11'- 9"	3942	1
264/66/5-8	40	2842	14200	6'- 1"	8'- 4"	18'- 6"	7'- 5"	19'- 4"	8'- 3"	20'- 11"	9'- 10"	22'- 3"	11'- 2"	4539	2
316/66/6-8	48	3401	17040	6'- 1"	8'- 4"	18'- 6"	7'- 5"	19'- 4"	8'- 3"	20'- 11"	9'- 10"	22'- 3"	11'- 2"	4627	2
369/66/7-8	56	3972	19880	7'- 3"	9'- 6"	18'- 6"	7'- 5"	19'- 4"	8'- 3"	20'- 11"	9'- 10"	22'- 3"	11'- 2"	5124	2
422/66/8-8	64	4542	22720	8'- 4"	10'- 8"	18'- 6"	7'- 5"	19'- 4"	8'- 3"	20'- 11"	9'- 10"	22'- 3"	11'- 2"	5717	2
475/66/9-8	72	5113	25560	9'- 6"	11'- 10"	18'- 6"	7'- 5"	19'- 4"	8'- 3"	20'- 11"	9'- 10"	22'- 3"	11'- 2"	6261	2
528/66/10-8	80	5683	28400	11'- 0"	14'- 1"	19'- 1"	8'- 0"	19'- 11"	8'- 10"	21'- 6"	10'- 5"	22'- 10"	11'- 9"	7271	2
580/66/11-8	88	6243	31240	12'- 2"	15'- 3"	18'- 6"	7'- 5"	19'- 4"	8'- 3"	20'- 11"	9'- 10"	22'- 3"	11'- 2"	7915	3
634/66/12-8	96	6824	34080	12'- 2"	15'- 3"	18'- 6"	7'- 5"	19'- 4"	8'- 3"	20'- 11"	9'- 10"	22'- 3"	11'- 2"	8014	3
686/66/13-8	104	7384	36920	13'- 3"	16'- 5"	18'- 6"	7'- 5"	19'- 4"	8'- 3"	20'- 11"	9'- 10"	22'- 3"	11'- 2"	8516	3
739/66/14-8	112	7955	39760	14'- 5"	18'- 8"	19'- 1"	8'- 0"	19'- 11"	8'- 10"	21'- 6"	10'- 5"	22'- 10"	11'- 9"	9021	3

All dimensions are rounded to the nearest inch - see engineering drawings for installation details.

Key: example. MJC 211/66/48 has 211 sq m filter area; Type 66 cartridges; 4 cleaning valves cleaning 8 cartridges per valve.

MJC Specification

Construction

Welded painted steel, clean air chamber 14 gauge thick steel; dirty air chamber 14 gauge; hopper typically 12 gauge thick.

Strength

Maximum negative and positive operating pressures:

Standard: minus 32" wg to plus 8" wg

Optional: minus 60" wg to plus 20" wg

Optional version has 12 gauge steel dirty air chamber plus extra internal stiffening in clean air chamber; to special order.

For explosion relief area calculation **St1, St2, St3:**

Reduced explosion pressure **Pred = 0.2 bar.**

Operating temperature

Standard unit: - 15° to + 175°F

Optional High Temp. Unit: - 15° to + 480°F

Features: Goyen diaphragm and seals
Silicone panel sealant
High temp. Paint
Suitable cartridges

Compressed air requirement

Normal operating pressure for cleaning air: - 90 psi (dry and oil free)

Typical compressed air consumption for 2 minute continuous cleaning cycle (for units with up to 12 valves); or 10 second interval between pulses (for units with more than 12 valves). Based upon 2.6 ft³ at NTP per pulse.

No. of valves	3	4	5	6	7	8	9	10	11	12	>12
CFM at NTP	3.9	5.3	6.6	8.0	9.3	10.6	11.9	13.0	14.5	15.9	15.9

Note: - use of "clean-on-demand" or increased cleaning cycle time will reduce typical compressed air consumption.

Electrical requirement

Controller: - 240/220/110Vac input (24 Vdc to special order only)

Fan: - 230/ 460V 3ph 60Hz (USA) (other voltages available by request)

UniClean Patent Cartridge

The UniClean cartridge was the result of an exhaustive design project with the purpose of increasing the effective cleaning pressure within the cartridge and equalizing its effect over the complete length of the cartridge. The UniClean device is a simple but very effective component integrated into the construction of the cartridge element.

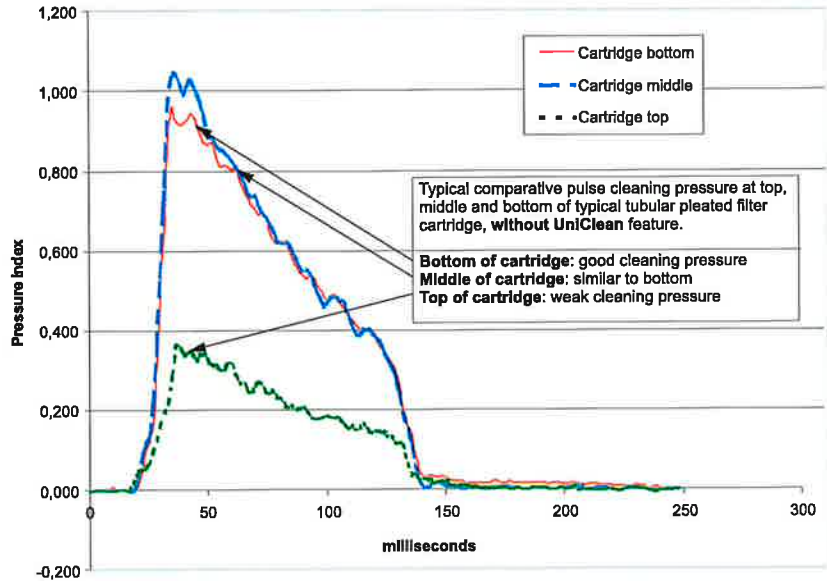

Fig. 2: 4m² Ø200 dust loaded cartridge without UniClean

The graphs illustrate benefits achieved by this patented invention.

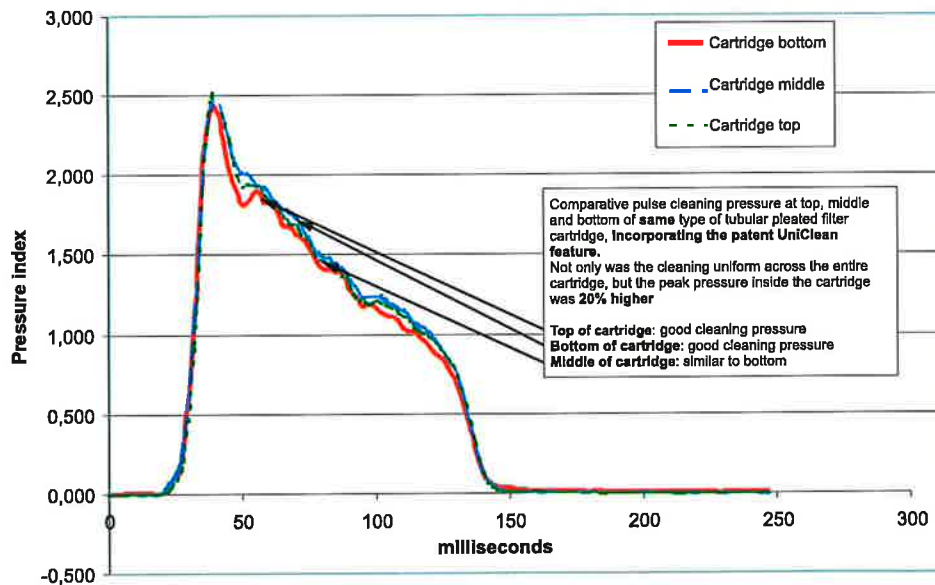

Fig. 3: 4m² Ø200 dust loaded cartridge with UniClean

- Higher internal cleaning pressure reduces cleaning requirement and thus compressed air consumption, increasing cartridge life.
- Uniform cleaning of complete cartridge increases effective filter area and reduces differential pressure, saving fan power and energy costs.
- Lower compressed air pressure requirement; increased cartridge life

MJC cartridge materials

At the heart of every MJC cartridge filter is the [Dantherm UniClean](#) patent pleated cartridge element.

The overall dimensions, including pleat depth and spacing were designed uniquely for the MJC and its small sister MJC Mini, and Silosafe. Ten years experience in many applications and the more recent introduction of the UniClean feature ensure maximum performance and long life.

The MJC range, uses a **Type 66** with 71 sq ft. per element.

Filter materials are:

- **CA100** high quality thermal bonded polyester pleated fabric as standard.
- **CA140** as CA100 but with metallized antistatic treatment.
- **CA190** as CA100 but with ptfе dust release treatment.
- **CA175** is a 90% cellulose, 10% polyester material available to special order.

Surface filtration.

The filter media is typically around 0.067 inches thick but contains many layers of random fibers. Filtration occurs at or very near the surface of the material and its efficiency (**BIA class U,S,G,C**) may be further enhanced by a surface layer of dust.

For light dust loads, or very fine dust, it may be beneficial to pre-coat the filter by introducing used dust, or a special pre-coat material. Please ask for information.

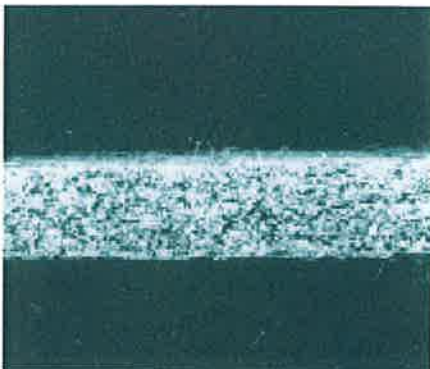

Cross section CA100

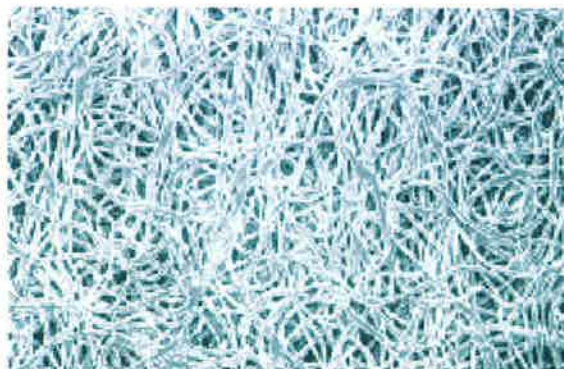

Surface magnified x 20

MJC

Built in Fans

MJC Fan performance and selection

MJC units may be fitted with space saving integral high efficiency radial fans. Single fans can deliver up to 8,250 cfm but some larger units may be fitted with two fans. A floor mounted version of the same fan range is also available as an option.

Fan Performance

The curves show the fan inlet static pressure vs. airflow volume for the integral fans running at 2-pole motor speed (2900 rpm with a 60 hz supply).

To select a fan for use with an MJC filter unit, first determine the airflow volume, then the static pressure required at that airflow volume as follows:

- Determine the static pressure required for the application (hoods, ducts, cyclone if used).
- Add 1.2" wg for the filter inlet resistance.
- Add 4" wg for bag resistance. For some "difficult" dust applications, add up to approx 8" wg.
- Add 1" wg for a silencer, plus any outlet duct resistance.
- The sum of 1+2+3+4 above is the static pressure required from the fan.

Fans for larger installations

Larger installations may be served by separately mounted **Combifab** fans when appropriate. **Combifab** is a range of high efficiency low noise fans with three impeller types to suit clean air, dusty air or for waste transport duties.

For clean air extraction from an MJC filter unit, the **Combifab** Type R, with backward curved blades is the most suitable.

Combifab fans may be directly or belt driven, with drive arrangements to suit the site and impeller speed.



- Airflow volumes up to 41,000 cfm.
- High efficiency up to 87%.

A floor mounted Combifab fan will be a practical, cost effective solution if more than one integral fan would otherwise be required to meet the airflow volume demand.

Please refer to the Combifab brochures for further details as required.



Fan Curves

Performance of standard integral fans 1 to 25 hp

Fan performance, with open outlet, at running speed 2900 rpm. Detachable fan used on MJB and MJC.

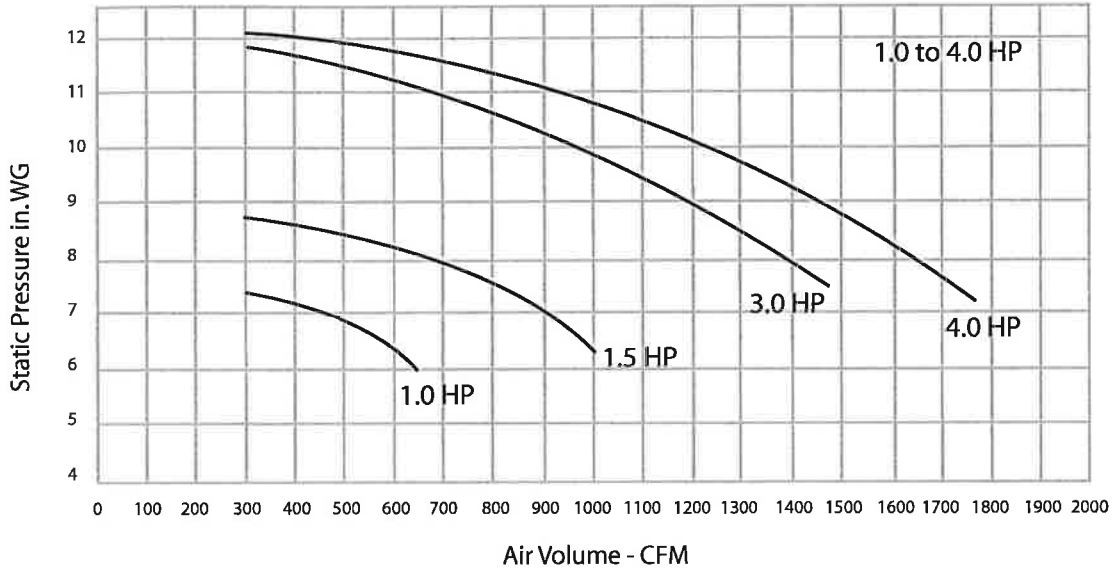

Fan performance, with open outlet, at running speed 2900 rpm. Detachable fans used on MJB and MJC.

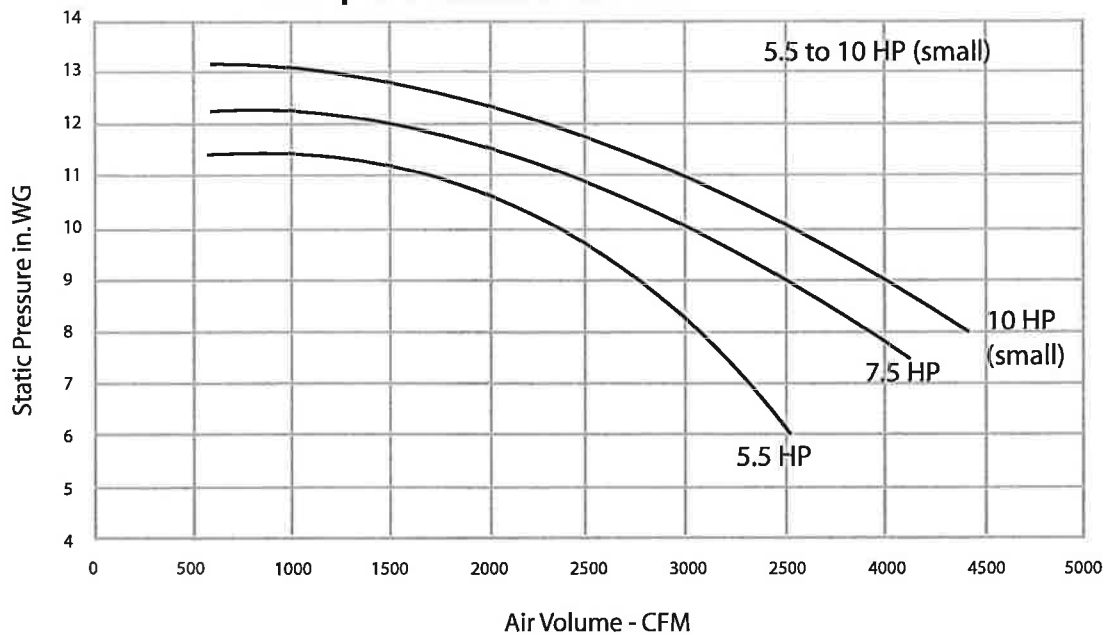

Fan Curves Cont...

Fan performance, with open outlet, at running speed 2900 rpm. Detachable fans used on MJB and MJC.

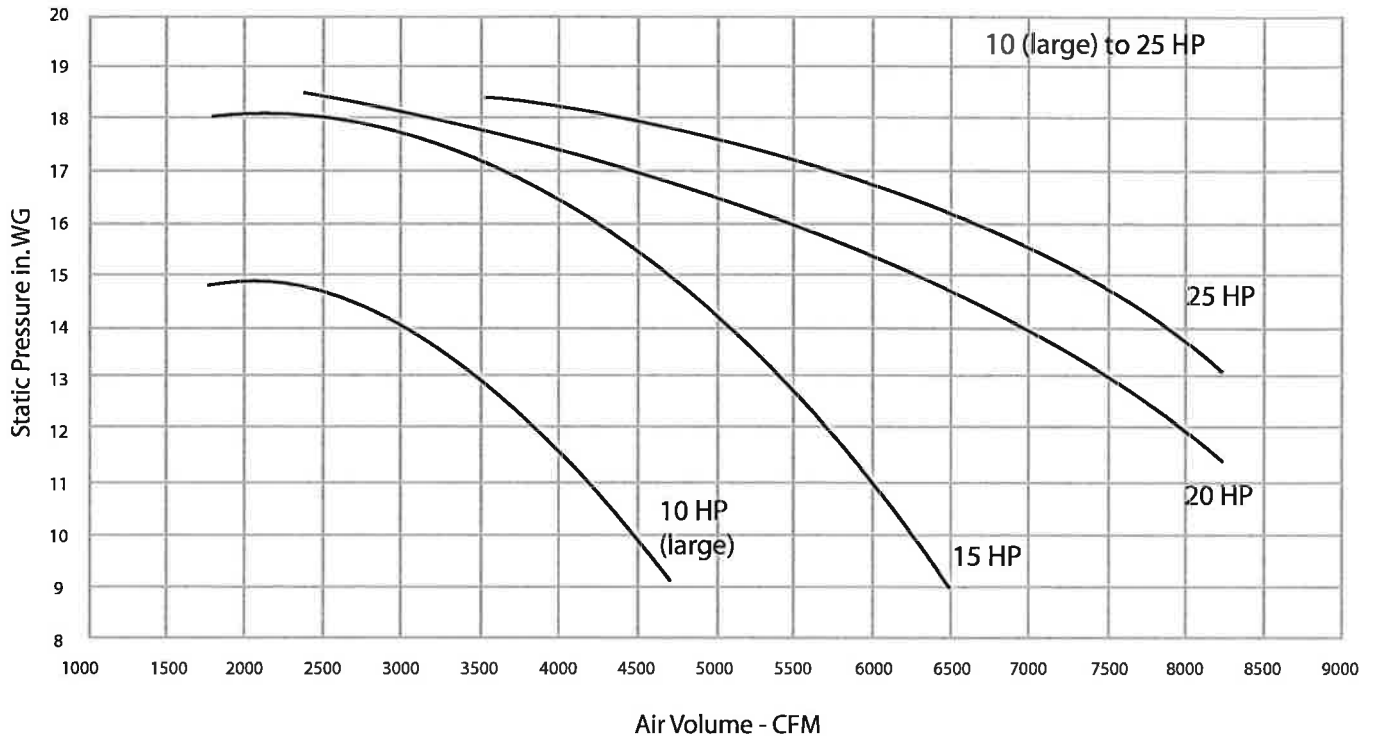

MJC Mini & SiloSafe Filters

MJC Mini



- Compact sizes 43 to 441 sq ft
- Explosive panels if required
- Short installation time
- Integrated Fan (1 to 4 hp)
- Low height, small footprint
- Clean-air-side cartridge replacement.
- Powerful but quiet

Suitable for many different applications that generate light to heavy volumes of any dust

SiloSafe 24 & SiloSafe 24F



- 8 gauge thick gauge fully welded steel construction
- Low profile design
- Hot-dip galvanized finish for longer life corrosion free service
- 258 sq ft filtration area
- Ease of maintenance from top-removal cartridge design
- Dantherm's Unclean cartridge design for longer life, 6000 hrs.

The SiloSafe 24 & SiloSafe 24F are cased, pulse-jet filters designed for use on pneumatically filled silos with base mounting flange.

**Metal • Cement • Powder Bulk • Welding • Plastic
Petro-Chemical • Pharmaceutical • Food**

MJC

Options

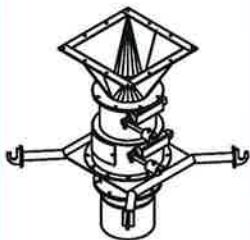

Double flap valve discharge for big bag

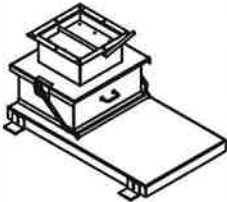

20 Gallon Bin

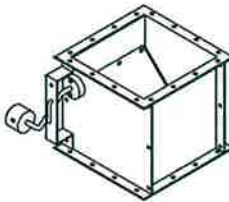

call for price
NFSU-3 counter balance dump valve

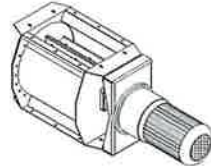

Rotary Airlock NRS-4 fabricated

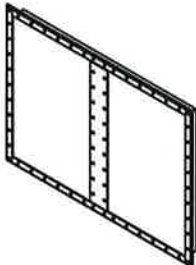

Explosion relief panels

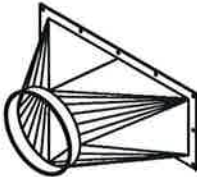

Inlet transitions flanged to round

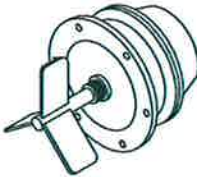

call for price
Bindicator

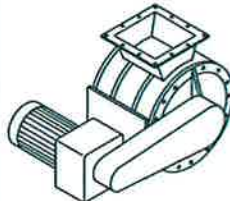

10" cast rotary airlock. Flex tip w. 1 hp - 230/460V



Fan outlet weather cowl

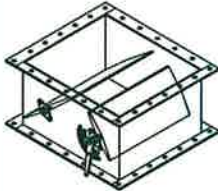

Fan discharge damper opposed blade

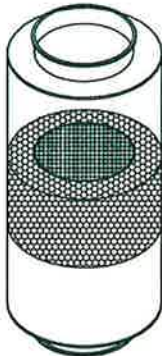

In line silencer

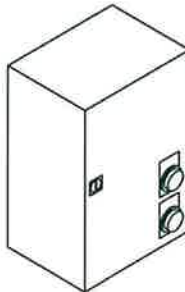

Fan motor starter 230/460V - 3 hp

Options

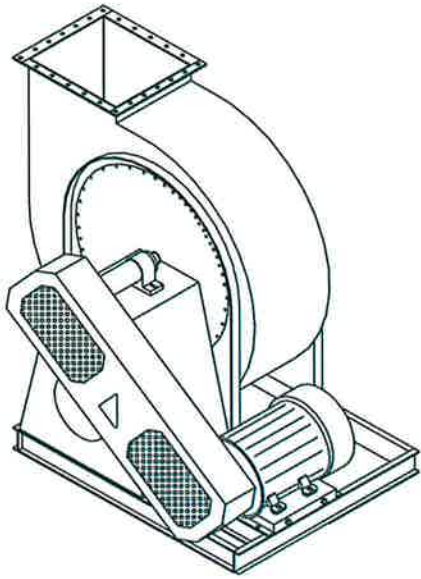

Ground mounted fans

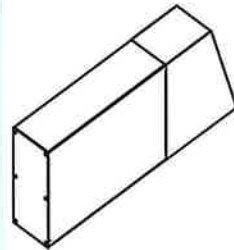

Detachable Fan
1.0 to 25 hp

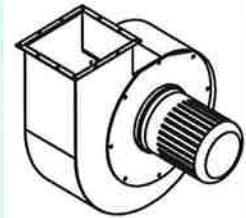

Air silencer with weather cowl for side mounted fans

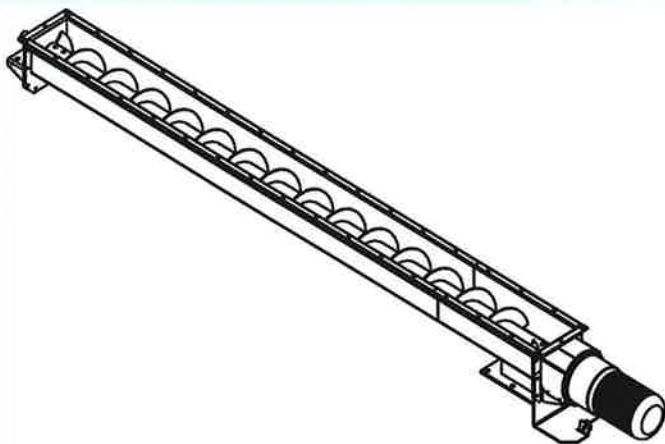

9" diameter screw conveyor
w 1 hp 230/460V

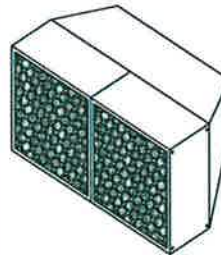

call for price
HEPA filter kits
call for price

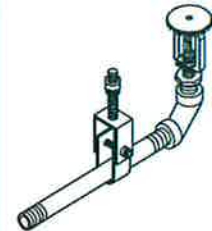

call for price
Filter sprinkler
call for price